



ACROSS INTERNATIONAL



OPERATION MANUAL

Laboratory Refrigerator

110V/60HZ

M35

Content

1. INTRODUCTION.....	1
2. PRECAUTIONS FOR SAFE OPERATION.....	2
3. PRECAUTIONS FOR USE.....	4
4. Installation.....	4
4.1 Installation environment:	4
4.2 Installation site:	4
4.3 Cautions before use	5
4.4 Standing	5
4.5 First initial starting	5
5. Refrigerator Components.....	6
6. Display panel function description	7
7. Defrost ●Unused ● Maintenance	11
7.1 Defrost, Unused and Maintenance	11
7.2 Disposal	12
8. After-sale Service	12
Annex 1: Rechargeable Battery Maintenance, Installation, Replacement and Disposal	13
Anex2: About installation of printer paper for optional part printer...	13
Anex3: Remote alarm terminal and RS485 interface	14
9. Specifications	14
10. Mainly use performance and indicators.....	15
10.1 Main technical parameters.....	15
10.2 Packing list:	15
10.3 Electrical schematic diagram:	15

1. INTRODUCTION







- Thank you for choosing Across International's bio-medical products.
- Read this manual carefully before using the appliance and follow the instructions for the safety operation.
- Keep this manual in an adequate place to refer to it as necessary.
- We never guarantee any safety if the appliance is used for any objects other than intended use or used by any procedures other than those mentioned in this manual.
- The contents of the manual will be subjected to change without notice due to the improvement of performance or functions.
- Contact our sales representative or agent if any point in this manual is unclear or if there are any inaccuracies.
- No part of this manual may be reproduced in any form without the expressed written permission of us.













- Please read the page4-page7 carefully as it contains the important safety notices.
- Only trained or authorized personnel could operate this medical freezer.
- Only qualified service personnel or authorized agent could install and maintenance this device.









- Use our spare parts as always. If users want to use other accessories, AI bio-medical will not be responsible for the adverse consequences. However users could apply for verifying the eligibility of these accessories from us before use them.
- Should inspect and maintenance the device in a specified time interval.
- Due to the differences between each models and the improvements of products, actual product may differ from the diagram. Please refer to the final product.
- Everyone has an obligation to be responsible for his or her own safety.
- Put on dry gloves when you take out refrigerated articles from the freezer.
- Handling frozen contents or the inside walls with naked hands may cause frostbit.











2. PRECAUTIONS FOR SAFE OPERATION

For the first time to use this device, users must read the meaning of the following warning labels very carefully. Items and procedures are described so that you can use this unit correctly and safely. If the precautions advised are followed, this will prevent possible injury to the user and any other person.

 WARNING: Failure to observe WARNING signs could result in a hazard to personnel possibly resulting in serious injury or death.	 CAUTION. Failure to observe WARNING signs could result in injury to personnel and damage to the unit and associated property.
 CAUTION HOT. The sign inform the users about the danger of burns for high temperature.	 DANGER OF EXPLOSION The sign inform the danger of the application of volatile, explosive chemical substances.
 NO TILTING .	 STAY OUT OF SUN.

 WARNING. Failure to observe WARNING signs could result in a hazard to personnel possibly resulting in serious injury or death.
 As with any equipment that uses CO2 gas, there is a likelihood of oxygen depletion in the vicinity of the equipment. It is important that you assess the work site to ensure there is suitable and sufficient ventilation. If restricted ventilation is suspected, then other methods of ensuring a safe environment must be considered. These may include atmosphere monitoring and warning devices.
 Do not touch any electrical parts such as the power supply plug or any switches with a wet hand. This may cause electric shock.
 Only qualified engineers or service personnel should install the unit. The installation by unqualified personnel may cause electric shock or fire.
 Be sure to install the unit on a sturdy floor. If the floor is not strong enough or the installation site is not adequate, this may result in injury from the unit falling or tipping over
 Carefully with the power cord to avoid short circuit or open circuit. When removing the plug from the power supply outlet, grip the power supply plug, not the cord. Pulling the cord may result in electric shock or fire by short circuit. Don't make the power line pack and pressed by furnish or heavy goods. Also please don't close to the compressor and heat source.
 Please insert the power plug firmly to avoid leakage.
 Use a power supply outlet with ground (earth) to prevent electric shock. If the power supply outlet is not grounded, it will be necessary to install a ground by qualified engineers. Don't lengthen the line randomly. If you need, To use 2.5mm ² copper line, you should keep 4mm ² line to connect the electrical outlet. Or may cause fire.
 Make sure a dedicated power source is used as indicated on the rating label attached to the unit. Out of the rate, should install a property transformer and a proper voltage stabilizer for securely operation. Or the freezer may be damaged, and may cause injury.
 Be sure to install the unit on a sturdy floor, no shaking and tilting.
 Never install the unit in a flammable or volatile location. This may cause explosion or fire.
 Never install the unit in a humid place or outdoor or a place where it is likely to be basked straightly. Deterioration of the insulation may result which could cause current leakage or electric shock.
 Do not place the device lateral tilt, do not impact the device; the device is equipped with refrigeration systems, roll or shock will easily damage the freezer.

	Be sure to install the device in a dry dust-free environment to avoid overheating, short circuit and other dangers
	If there is an unexpected sound, smell, smoke when the power is turned on, unplug the power and contact the manufacturer or supplier. Continued abnormal operation may cause electric shock or fire.
	Make sure to put the freezer in a dry and ventilated environment, to ensure that equipment vents and wall surface of the instrument or other items have not been blocked; Do not use the device in a poorly ventilated environment, or the equipment may be damaged by the release of heat.
	Never disassemble, repair, or modify the unit yourself. Any such work carried out by an unauthorized person may result in fire or injury due to a malfunction. Meiring will be no responsible for such work.
	Never store volatile or flammable substances in this unit. This may cause explosion or fire. Never store corrosive substances in this unit. This may lead to damage to the inner components or electric parts.
	Use this unit in safe area when treating the poison, harmful or radiate articles. Improper use may cause bad effect on your health or environment.
	Never ground the unit through a gas pipe, water main, telephone line or lightning rod. Such grounding may cause electric shock in the case of an incomplete circuit.
	Use a power supply outlet with ground (earth) to prevent electric shock. If the power supply outlet is not grounded, it will be necessary to install a ground by qualified engineers

	CAUTION: Failure to observe WARNING signs could result in injury to personnel and damage to the unit and associated property.
	The medical freezer is not available to store non-living things, flowers, or other critical articles which is not suitable for low temperature storage.
	The temperature inside the freezer is very low during the normal working. Do not touch the interior surface of the chamber or the object inside without wearing protective gear.
	Always disconnect the power plug when the unit is not used for long periods.
	Make sure to prepare a safety check sheet when you request any repair or maintenance for the safety of service personnel. Be sure to check set point of the controller prior to restart the freezer.
	The ultra-low temperature freezer is a storage device, not a production equipment!
	Always hold the handle when closing the door. This will reduce the likelihood of a trapped finger.
	Keep the key properly avoiding the children take it to open the back door which may result in unexpected injury.
	Select a level and sturdy floor for installation. This precaution will prevent the unit from tipping. Improper installation may result in water spillage or injury from the unit tipping over.
	Check the filter mentioned in this manual and clean it as necessary. A dusty filter may cause.
	Do not tilt the unit more than 45 degrees when moving the unit. All transportation should be carefully.

3. PRECAUTIONS FOR USE

- ◆ Before you put the items to the medical refrigerator, please make sure whether the temperature in the refrigerator has reached the set temperature and then put the items to the refrigerator in batches. No more than 1/3 of the refrigerator rating volume per time, in case the temperature rises too much.
- ◆ Medical refrigerator temperature display value shows the temperature around the temperature sensors. Sometimes, there is certain difference between the display temperature and the actual temperature in the center of the refrigerator, but it will gradually close to the real temperature.
- ◆ Clean the refrigerator with the diluted neutral detergent. Do not use brushes, acid, gasoline, soap powder, polish or hot water to clean the medical refrigerator, as the above material may damage the painted surface and plastic rubber parts. Be careful not to use volatile solvents such as gasoline to wipe plastic rubber parts.
- ◆ The power should be cut off while the medical refrigerator does not use for a long time.

4. Installation

4.1 Installation environment:

- Ambient temperature: 16°C ~ 32°C, optimal ambient temperature : 18°C ~ 25°C, Air conditioning system is required if necessary.
- Relative humidity: ≤80%RH.
- No strong vibration and no corrosive gases around.
- Without the presence of a lot of dust.
- No shaking or vibrating of the freezer.
- Altitude of the place where the freezer is located : ≤2000m
- Input voltage ≤220+10% (V).
- No direct sunlight or any other cooling or heating source, no electromagnetic interference, or the freezer will not run properly.

4.2 Installation site :

This unit is a precision machine. When select a location to install this unit, keep the following conditions for perfect performance

- Should not be installed in a small confined space, the door of the room should not be less than height of the present equipment.
- Install the unit on a sturdy floor to avoid excessive vibration and noise.
- Installing the unit in direct sunlight may cause malfunctioning and may shorten the life of the unit. Keep good ventilation is necessary.
- Socket inputs should be connected to circuit protection facilities,
- Checking the working voltage of the place before start the freezer. A voltage stabilizer is suggested to be used at the place where the voltage is not stable. Make sure the normal input voltage stable at or 220V± 10%, Power of voltage stabilizer should be more than 4KW.
- Be sure to ground the unit;
- If the power cord socket is equipped with grounding wire, check the connection before use.
- If the power supply outlet is not grounded, it will be necessary to install a ground by qualified engineers

! Warning

- Do not touch gas pipe, water pipe, line or lightning rod to medical grounding cooler, easy cause electric shock
- After installation, power plug must be within reach, convenient unplug the power cord in time in case of an emergency
- Any articles shall not cover medical air vents of the medical refrigerator

4.3 Cautions before use

a. Remove all package components (include the protection foam inside the package)

! **Caution:** Do not put the packing plastic bag within reach of children as suffocation may result

b. Check the device, accessories and document with the device as per list of packing

c. Installing the door handle

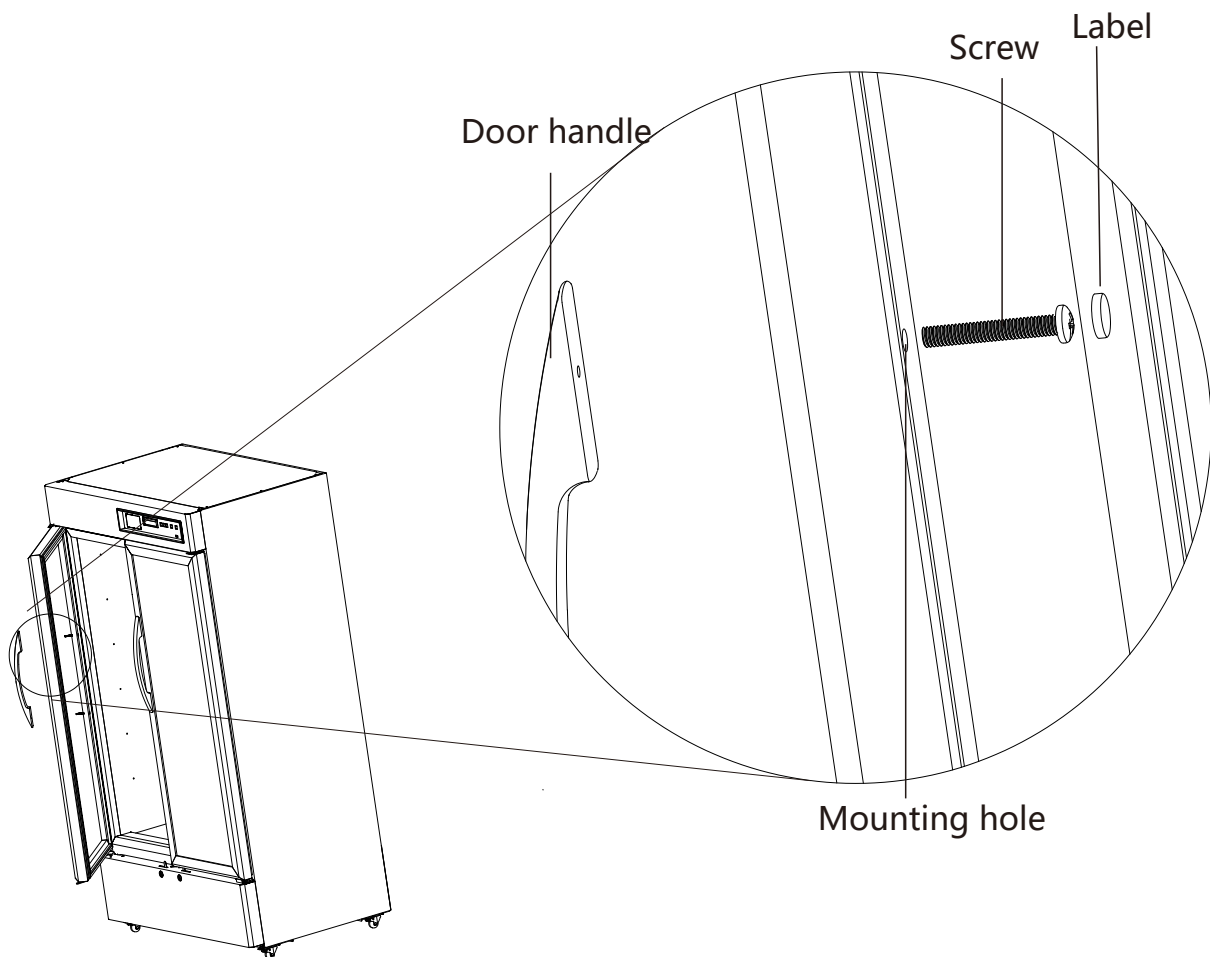

How to install the handle:

First open the refrigerator door as shown above, remove the door seal in the side of the handle, and insert the screw through the mounting hole on the door; then fix the handle to the door by screws (you can use the simple screwdriver in the accessory bag) ;

Finally, cover the mounting hole on the door body with the label, and reinstall the door seal in the card slot above the door body.

d. Clean: make a clean of the device before use it.

4.4 Standing

Do not turn on the freezer at once when the freezer is well located, must wait 24 hours for the first start.

4.5 First initial starting

Operate as follows for the first start:

1. Connect the power cord to the appropriate socket during no-loading.
2. Check the temperature to achieve the required temperature, medical refrigerator for normal open stopped more than 24 hours, after equipment performance is normal, can put a small amount of items placed in medical refrigerator. (Please put the items in batches. Each time, the items shall be put less than 1/3 of the unit capacity. Another less than 1/3 of the unit capacity items shall be put after the refrigerator compressor is been regularly opened and stopped for at least 12 hours)
3. Do not open the door during the cooling process, will cause the temperature rise.
4. There must be an authorized person responsible for the freezer in customer's office, to check the operation status and make daily record. The inside temperature of cabinet will rise up during the failure problem, if it is not available to be repaired in a short time, take out the stored items and transfer to other safe locations.
5. Prior to put the articles inside the freezer, should check if the temperature set range of this device is matching the requirement of the articles.
6. Due to the Inertia of refrigeration, there is a little difference between the actual temperature displayed on the controller and the set temperature. This is a normal phenomenon.
7. Medical Refrigerator are storage devices, do not put excess "hot" samples into the freezers at one time, or will cause compressor damage after long time working without stop. Attention to put in samples and set temperatures in batches.
8. Do not put electric devices in the freezers without permission.
9. Do not change the setting temperature frequently within a short time, or the current temperature may not reach the setting temperature as the inertance; Do not cover sensors in the freezer when you put in samples and keep some distances between the samples and the inner side of the freezer to make sure the cold air will circulate successfully in the freezer, or will cause the instability of the inner temperature and inaccuracy of the display temperature.
10. Operation after power failure.
11. The freezer controller has memory of the set point. The freezer will continue to follow the previous operations when restart the freezer after the power failure. The restart should be done after 5 minutes in case to damage the compressor.

5.Refrigerator Components



As the product is improved and the model is different, the actual product may be different from the simple diagram.

The above picture is only the example of identifier function piece. Structure and composition: the product consists of a box, a glass door structure, a refrigeration system and a control system. Scope of application: This product is suitable for hospitals, pharmacies, epidemic prevention stations, research institutions, biopharmaceutical departments and so on.

6. Display panel function description

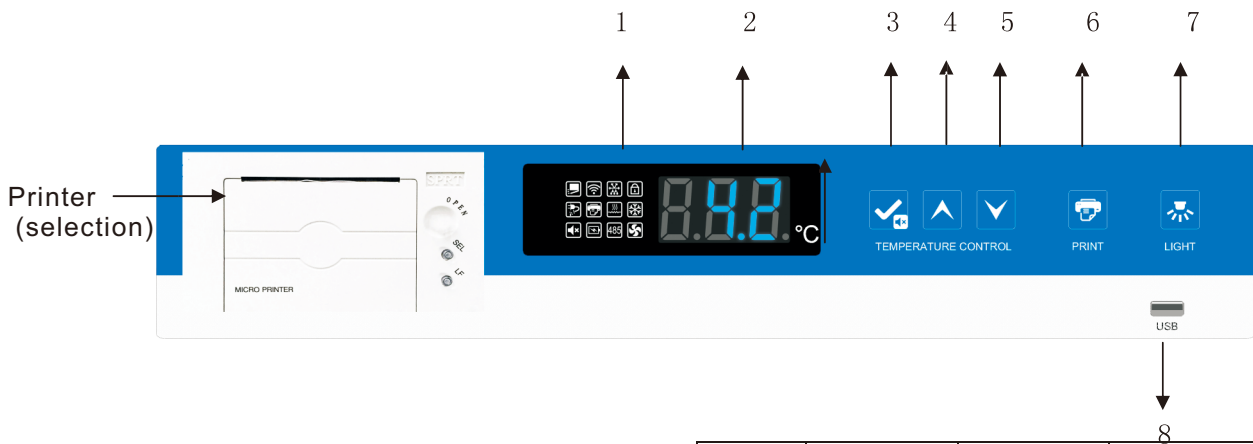

1.Functions represented by each indicator: (the right table)



Door switch	WIFI	Defrosting	Key lock
Power failure	Print	Door heating	refrigeration
Mute	Electricity	serial port	Fan

a. Door switch indicator

When the door opened, the light on; when the door is closed, the light off.

b. Defrosting indicator

When the refrigerator enters the defrosting state, the defrosting indicator is often bright; when the refrigerator is out of the frosting state, the defrosting indicator is often extinguished.

c. key lock indicator lamp

When the key is locked, the key is not responding, and the key button is lit. At this time, the key is followed by the long key and the lower key 3S. It prompts the input password. The default is "005". After entering correctly, press the set / mute multiplex key, and the key is locked and released. At this time, the key lock indicator lights go out. In the unlocked state, 60s has no buttons, the key lock starts, and the key lock light is lit. Press the top key + lower key 3S, the key is locked.

d. Power outage indicator

The refrigerator is normally powered by 220V. When the input power is off, the buzzer alarm. The digital tube alternates with the 3S interval. The power code is "PF". The power failure indicator lights up. When the input power is connected, it returns to normal, and the power off indicator lights go out.

e. Door heating indicator lamp

When the door is closed door heating, heating lights go out; when the door opened the door when heating, the heating indicator light.

f. Refrigeration indicator lamp

If the compressor is in the working state, the refrigerating indicator light is on; if the compressor is in a shutdown state, the cooling indicator off

g. Low power indicator lamp

When the battery voltage is less than 10.8V, the buzzer gives the alarm, and the electricity is low. The indicator lights up. the digital tube alternates with the 3S interval, the battery is low, the code is "PL". When the battery voltage is more than 12V, the buzzer is turned off, and the low power indicator lights go out ,it returns to normal,

h. Print indicator

When the printer is not working, the indicator lights out; when the printer is working, the indicator light is lit.

i. Serial port indicator

When the refrigerator is not connected to the reserved RS-485 serial port, the serial port light is extinguished; when the refrigerator is successfully connected to the RS-485 serial port, the serial port light is lit.

j. Fan indicator lamp

When the evaporator is opened, the fan indicator is opened; when the evaporator is closed, the fan indicator is extinguished.

k. Mute indicator lamp

When the alarm tone is silent, the indicator light is lit; when the alarm sound function is cancelled, the indicator light is extinguished.

1. temperature display window, in normal running state, display the average temperature inside the box, the unit is centigrade.

Environmental temperature view:



A key lock state, press the button , digital display temperature, no button operation after 5 seconds or press 、

Return to normal display.



The key is not locked, press the button , digital display temperature, no button operation after 5 seconds to return to normal display.

Humidity check: key unlocked state, long press  and , digital tube display humidity, no press

Key operation after 5 seconds or press 、, return to normal display.

2.  a set / mute key; When there is no alarm state, the button is not unlocked, press , the ambient temperature is displayed for 5s and then the normal display is restored; in the unlocked state, the press  can enter the user's menu for more than 3 seconds.

When the buzzer alarm (including the cabinet temperature overtemperature alarm, the door open alarm, the sensor fault alarm, etc.), the button is not pressed

The unlocking state, the first press , the buzzer stops chirping, display the ambient temperature 5S, return to normal display (press the mute key is only close the abnormal state of alarm buzzer, such as troubleshooting, abnormal alarm buzzer next to), press  again, buzzer alarm, 5S display temperature, recovery display cabinet temperature and alarm state. In the state of key unlocking, you can use  as the settings key.

In the unlocking state, when setting parameter mode, press this key to display the parameter and parameter name. If the press time is longer than 3 seconds, then save the settings and return to the normal interface.

3.  is the up-regulated key; in the parameter setting mode, you can move to the next parameter, or increase the parameter value. For example, when setting the set temperature, increase the set temperature. When the parameter values are set, the parameters increase quickly when the key is raised. In normal state, the U disk December data can be imported by pressing the top key for 3 seconds.

4.  the down key;

In the parameter setting mode, move to the previous parameter or reduce the parameter value.

For example, when setting the set temperature, the setting temperature is reduced.

When the parameter values are set, the key is down and the parameters are reduced quickly.

5.  is the printing key;

The system can keep the data for 7 days to print, and press the print key to print the temperature in the setting time.

6.  the key to the light opening.

The default lamp on the refrigerator is closed. The key is to press the light, and the turning light can be turned out. When the lamp is closed, the lamp is lit and the lamp closes when the door is closed; when the light is on, the light does not change when the door is closed. This machine has two functions of automatic lighting and manual lighting. In the automatic lighting condition, the door opened the door immediately lights lit, turn off the lights after 5 seconds off; the user can manually control the lights turn on the lights, not switch the door has been lit (indicating lamp button above the light), only once again press the key to open the lamp lighting lamp can turn off manually enter the automatic lighting state after automatic lighting (indicator button above out).

7. USB data export;

Automatic export: when the U disk is connected to the USB interface, the recorder buzzer calls once, displaying "on", and the PDF files in the U disk are generated during the month and the last month. After the data transmission is completed, the buzzer calls once, displaying "End", and then returning to normal display after 6S.

Note: when the data is less, "on" and "End" are not displayed on the digital tube.



Manually export: button keep unlocked, U disk connected, and not in the file generation, press the button 3 seconds, digital tube display "D01", according to the raised key or down button to adjust the "d00~d12" . press  button, U disk made this file (D00) or push forward the month (1-12) PDF document data.

Note: when the digital tube alarm flickers "LoF", the recorder is not started;press   at the same time, the "LoF" is disappearing for 3 seconds ,the buzzer sounded once and the recorder is started.

(2) functional settings:

A. connect the power supply, open the back power switch of the back of the box, and the machine can enter the working state.

B. user parameter settings:

To unlock: under normal operating conditions, and at the same time press   for 3 seconds, the digital display parameters

The code "000", enter the password "005" (the input menu user password, enter "099" can be the key to restore the default lock password "005".) It is unlocked at this time. After unlocking press  for 3 seconds, digital display

The display parameter code "PS1", enter the set parameters.

Use   to adjust

Display→PS1→b1→b2→Set→H→L

n→y→r→S→F→Pt→tH1→P1→P2

Press  to confirm the parameters, the first parameter name of this type of parameters will be displayed;

(1) rolling parameters with  or ;

(2)  displays the corresponding parameter value;

(3) use  or  increase or decrease the value;

(4) press  to return to the display parameters, value of the temporary storage.

(5)If other parameters are modified, repeat step 1 ~ (4);

(6)press  the above 3 seconds, modify the parameters stored and returned to the display parameter category.

C. if there is no key in 60S. Exits the parameter setting program

D. parameter display

Serial number	menu	Parameter range	Suggest setting values	Remarks
1	b1	V1.0-9.9	1.0	Hardware version
2	b2	V1.0-9.9	1.1	Software version
3	Set	4.0	4.0	Temperature setting
4	H	0.0~10.0	5.0	High temperature alarm set value set+H; H=0 when the alarm is cancelled. When the temperature is too high, the high temperature alarm shows H1
5	L	0.0~10.0	4.0	Low temperature alarm set value set-L; L=0 when the alarm is cancelled, when the temperature is too low, the low temperature alarm display L1
6	Pt	0~240 min	20	Print interval
7	tH1	20.0~50.0°C	40.0	Upper limit of ring temperature alarm
8	P1	1: automatic heating mode 1 2: automatic heating mode 2 3: automatic heating mode 3 4: open all the time 5; keep closing	1 the door body with condensation is set to 4	Mode 1: door door closing judgment once, heating 5min, (time can be set) if in the heating time period, the door opens again and closes again, refurbished heating time Mode 2: when the compressor is running, the heater opens; when the compressor is shut down, the heater is delayed for 1 minutes. Mode 3: when the humidity in the cabinet is greater than 80%, the door body is heated and opened, and the door body is heated and closed when the humidity is less than 60%. Mode 4: the door body heating has been opened. Mode 5: the door body heating has been closed.
9	P2	1: average temperature 2: upper temperature 3: lower temperature	1	Display mode selection
10	PS1	000~999	005	User menu password settings
11	MAX	/	/	View the maximum temperature
12	MIN	/	/	View the minimum temperature
13	CLR	0: Delete 1: Not to delete	/	Clear the maximum and minimum values of the temperature

(3) Alarm Display

Alarm code	Fault description
H1	High temperature alarm of sensor
L1	Low temperature alarm of sensor
H2	High temperature alarm for environmental sensors
H3	High temperature alarm of condenser sensor
do	Open the door to the alarm
PF	Power off alarm
PL	Low battery alarm
ER	Recorder is not connected
LoF	Recorder did not start
EE	Communication failure

Printer settings:

(1) Automatic printing, when the printing interval Pt is not 0, the printer prints the current data every Pt minutes.

Note: When the printing interval Pt is smaller than the recording interval SCy , it is printed at the recording interval; the remaining printing interval is printed at an integral multiple of the recording interval Scy , that is, the printing interval Pt should be set to an integral multiple of the bit recording interval.

(2) Manual printing, when the button is not locked and the working voltage is normal, press the print button to display "P01", press the up button or the down button to adjust "P00~P07", press the set/mute button or the print button. The printer cancels the manual printing (P00) or prints the data recorded when the number of days before the trip (1 to 7), and the printed data interval is the same as the automatic printing interval.

Just to switch on the power supply for medical refrigerator do not immediately add items, make empty operation after a period of time (about 24 hours), then refrigerated goods into storage box.

To add items, if the item is too much water or excessive drying will influence the change of the humidity, the best goods sealed; the same medical refrigerator working environment humidity size will also affect the change of the humidity of the door and the door body ,especially too much not close well.

For each store items can not exceed 1/3 cabinet capacity, achieve the actual temperature and normal operation after 24 hours, then add another 1/3 cabinet storage capacity.

To add items please do not block the outlet and inlet.

The goods can not be placed directly on the bottom of the medical refrigerator should be placed on the bottom shelf, otherwise the effect of medical refrigerator cooling effect.

The cooling process as far as possible not to open the door, otherwise it will cause temperature rise.

Due refrigeration inertia, the product reaches a set value when stopping the display temperature and the set temperature may have a certain difference

Different, this is the normal phenomenon.

Note: children are not allowed to play games in a medical refrigerator.

7. Defrost • Unused • Maintenance



Caution

- For personal safety, please cut the power supply before any maintenance!
- Don't inhale medications or aerosols around the device while maintaining a medical refrigerator, or it will endanger your health.

7.1 Defrost, Unused and Maintenance

The medical refrigerator will be automatically defrosted during the working process.

Unused: If the unit is not used for long time, please disconnect power supply and maintain as the following procedures.

Maintenance: Once in a while, the medical refrigerator should be cleaned and maintained. (For the sake of safety, remove the power plug firstly) and wipe the inner and outer surfaces of the refrigerator with a soft cloth.

Caution: DO NOT sprinkle water on the faces of cabinets, which may decrease insulating property of electric parts and rust metal parts. DO NOT use hot water, corrosive cleanser and organic solvent!

No violent vibration or collision during transportation. No rain drench.

Suitable conditions: temperature: $-40^{\circ}\text{C} \sim +55^{\circ}\text{C}$, relative humidity: 10% ~ 90%.

7.2 Disposal

Warning:

If the equipment is stored in unsupervised areas for a long period of time and leave unused, ensure that the child is not close to the medical refrigerator and the door cannot be closed completely. The disposal of refrigerator shall be carried out by corresponding personnel to prevent the occurrence of such accidents as suffocation.

8. After-sale Service

Any product has the possibility of failure. Please observe the operation of the medical refrigerator in the process of use. If there is any abnormality, please check and compare the errors with the following table. If you can't fix the issue, Please inform our service center in time. We will serve you wholeheartedly to avoid any losses.

Term of use: 10 years

Problem	Possible Cause
Refrigerator does not running	<ul style="list-style-type: none"> ● Power outage has occurred. ● The plug is bad or not securely plugged-in. ● Fuse is blown. ● Voltage is too low or high.
Compressor does not running	<ul style="list-style-type: none"> ● Power in control panel is off. ● Temperature setting is wrong.
Temperature is lower than setting	<ul style="list-style-type: none"> ● The door is not closed properly or is opened too frequently. ● Overfull materials are put. ● Ambient temperature is too high.
loud noise	<ul style="list-style-type: none"> ● Freezer is not leveled well. ● Freezer leans upon the wall.
Surface condensation of glass door	<ul style="list-style-type: none"> ● Wet and moisture season, the door may be condensed. It belongs to normal phenomenon, just wipe it with dry cloth.
Alarm flashing, buzz warning	<ul style="list-style-type: none"> ● If you just put in the item, the temperature is stable and will be eliminated automatically after running for a period of time. ● If the door is not closed tightly to cause the door open alarm. ● If the battery is low, it will be eliminated automatically for a period of time. ● Whether the temperature exceeds the standard

● **Below are normal operations:**

① There are some light clashes when the compressor starts up and stops.

② After opening the door and put in the hot subjects, the controlling system appears high temperature and high humidity alarm. solution: The hot subjects should be cooled by natural cooling and then put into the cooler. Do not put too many subjects at one time. After the system is stable, the high temperature and high humidity alarm will be relieved.

③ The slight flowing noise of running water in the refrigerant pipe.

④ Before call the service engineer, Please clean and disinfect the freezer.

Condition: Cannot shake heavily, strike, prevent to drenching.

Storing environment temperature: -40°C ~ +55°C, Relative humidity: 10% ~ 90%.

Annex1: Rechargeable Battery Maintenance, Installation, Replacement and Disposal

Long term power failure or in the process of transportation, the main power switch must be turned off. Otherwise, long time discharge will cause battery loss or permanent damage, and it will be abnormal after re-energized.

➤ Maintenance of rechargeable batteries: In order to prolong the battery life, please avoid idling the product. It is better to run the product more than 24 hours monthly to recharge.

Battery Maintenance

A. If the freezer does not run in a long time, it should be connected to the power on a regular basis (monthly), turn on the power switch to charge the freezer for a period of time, and the charging time is not less than 24 hours.

B. When the power supply is interrupted, the power lock switch should be turned off in time, otherwise the battery will lose power, which may cause permanent damage to the battery.

C. The battery is expendable and the battery life is about 2 to 3 years. If the battery is not properly used, such as the loss of electricity or reach the battery life, it will lead to low battery alarm. (It does not affect the usage of the refrigerator but there is alarm failure and influence on printing function. It is suggested that users should contact company after-sales service staff to replace.

1. Battery Installation Position: Top inside of electrical box

2. Battery replacement

a. Turn off the power switch and pull the plug from the socket (Pay attention to the electrical components in the electrical cabinet. Power supply must be turned off and also unplug the power cord and turn off the power switch of the freezer before opening. The electrical cabinet must be opened by qualified engineer or maintenance personnel).

b. Remove the battery connection plug. (Before unplugging the cord, pay attention to the sequence of the battery's positive and negative levels and the connecting line, does not upside down the positive and negative levels to prevent the control system damage from the installation of new batteries. The red line is usually connected to the positive pole, and the black line is connected to the negative pole)

c. Remove two fixed screws from the battery plate with a screwdriver and remove the battery.

d. New replaced battery model: BT-12M4.0AC(12V4.0AH);

e. The replacement battery is recyclable, please contact the local battery recycling agency for processing.

Note: In order to effectively ensure that the replacement tank battery meets the requirements of the control system and to avoid the impact of improper operation on the system during the replacement, it is recommended to contact the after sale service staff to replace or guide.

Anex2: About installation of printer paper for optional part printer.

The printing paper has been installed in the factory. When the paper is used out for a long time, you can buy and replace it with the same roll paper.

The installation steps are as follows:

1. Press the cylinder button on the printer and open the cover of the printer.

2. put print paper into the printer box and pull the paper roll end of the printer cover after the note slightly exposed on the box cover port;

Anex3: Remote alarm terminal and RS485 interface

The remote alarm terminal is installed in the back of refrigerator and the alarm signal is output by the terminal. The terminal bearing capacity is DC 30V, 2A.

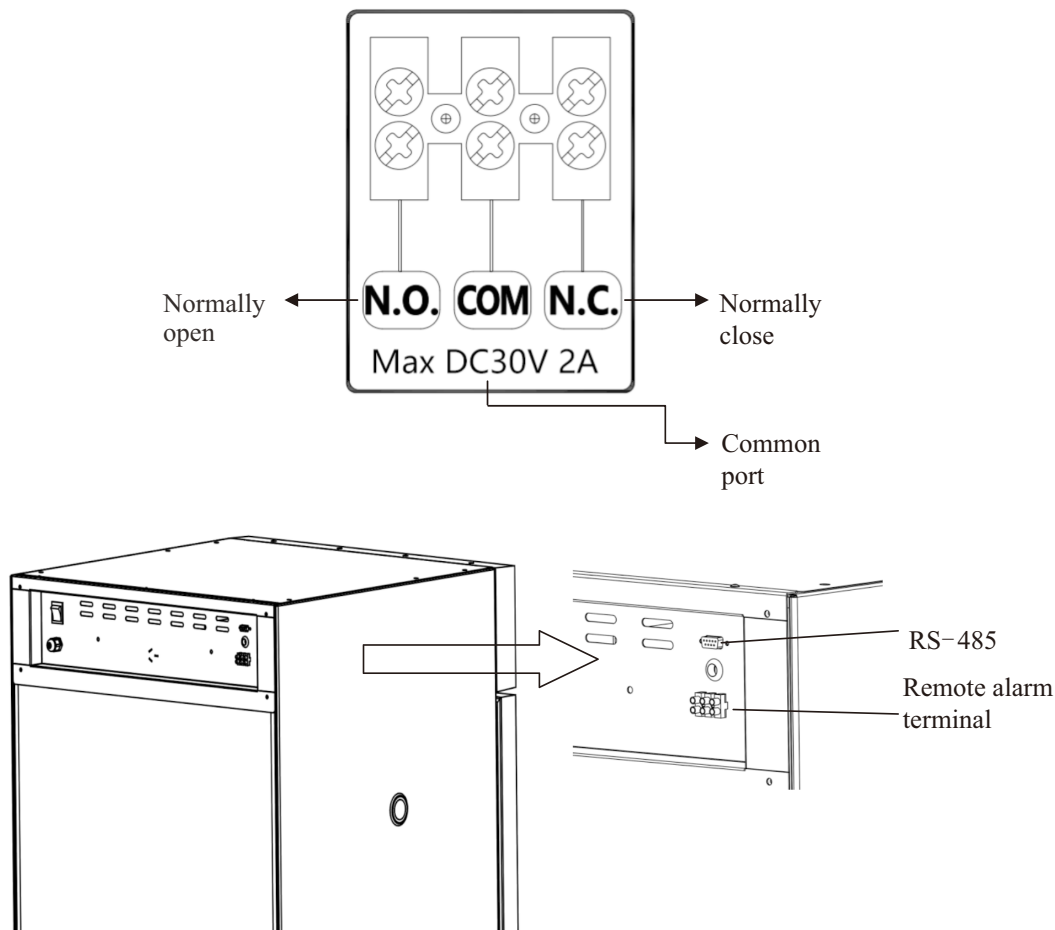

9. Specifications

Product name	Laboratory Refrigerator
Model name	M35
Box shell	PCM color coated sheet
Out door	Glass door
Condenser	Finned
Evaporator	Finned
Thermal insulation	Hard polyurethane foam filling
Compressor	Full sealed
Controller	Micro computer controlled
Temperature sensor	NTC
Alarms	High and low temperature alarm, door alarm, power failure alarm, low battery power alarm sensor fault alarm.

10. Mainly use performance and indicators

10.1 Main technical parameters

Model	Air TEMP	C-T	Refrigeratio n-Qty	RV(V~)	RP (Hz)	Tempera ture (°C)	EC(CU FT)	RC (A)	Net Weight (Kg)	ExternalSize (D×W×H) (mm)
M35	16~32°C	N	R290/130g	110	60	2~8°C	35	7.56	223	900×1180×1990

10.2 Packing list:

Name	Operation Manual	Keys
M35	1	2

10.3 Electrical schematic diagram:

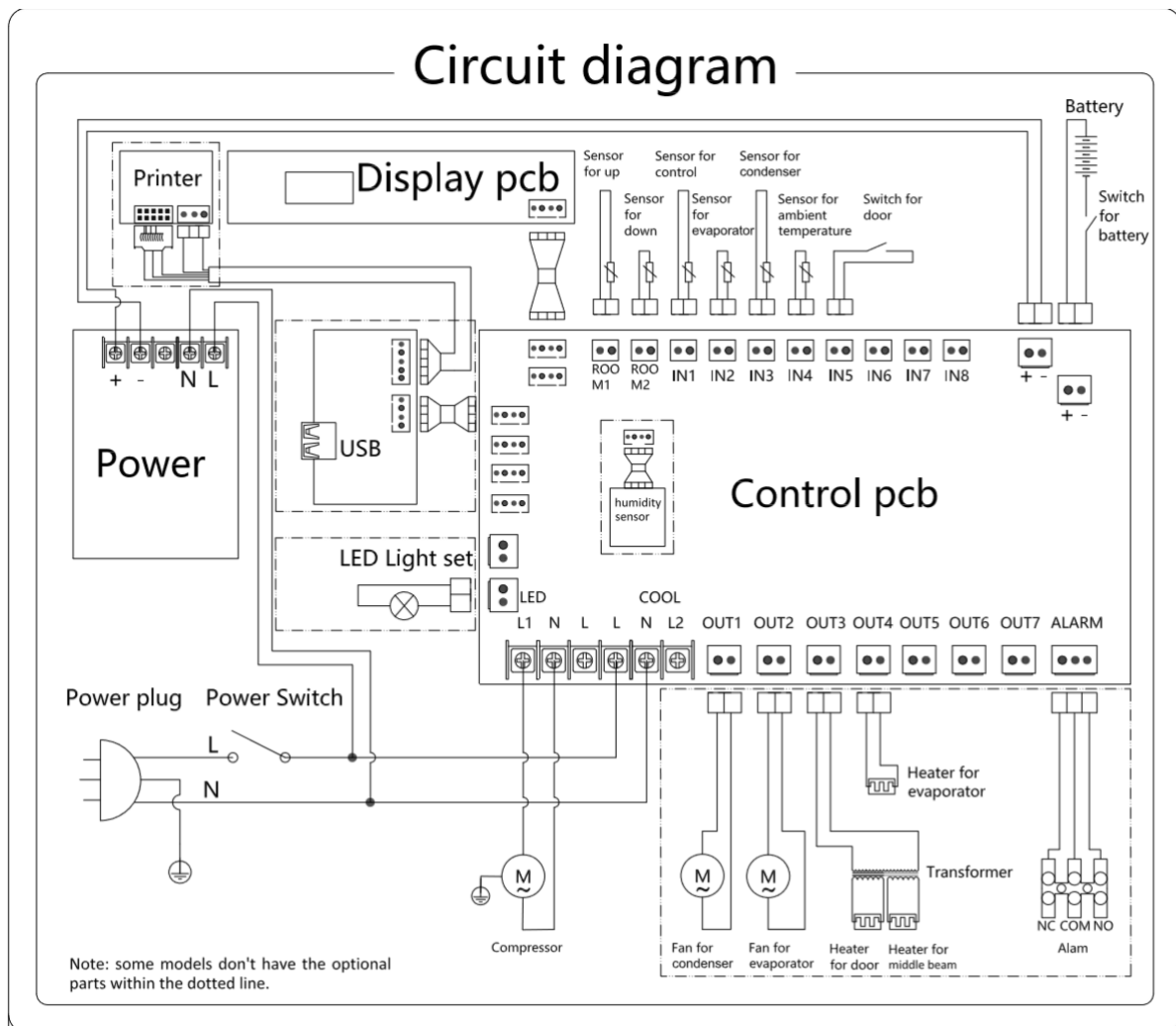

If the product is improved, the technical data and circuit diagram shall be subject to the final product nameplate and cabinet circuit label.

Across International, L.L.C.
111 Dorsa Ave
Livingston, NJ 07039-1002
United States



Ai United States

Phone: 888-988-0899 | Fax: 888-988-1899

111 Dorsa Avenue, Livingston, NJ 07039
1197 Greg Street, Sparks, NV 89431

Customer Service

- All inquiries: info@acrossinternational.com
- Order status or shipping: orders@acrossinternational.com

Technical Support

- support@acrossinternational.com

Sales

- quotes@acrossinternational.com